

ND105-4

4" Aluminum Cone Midbass Driver



Features

- Low distortion Neo-Sym motor structure
- 4-Layer underhung voice coil
- Black anodized aluminum cone
- Low loss rubber surround
- X_{MAX} 4 mm / 20 mm peak
- Extended frequency range

Parameters

Impedance (Ω)	4
Re (Ω)	3.7
Le (mH) @ 1 kHz	0.78
Fs (Hz)	53.8
Qms	7.16
Qes	0.59
Qts	0.55
Mms (g)	7.2
Cms (mm/N)	1.2
Sd (cm ²)	51.5
Vd (cm ³)	20.6
BL (Tm)	3.9
VAS (liters)	4.5
X _{MAX} (mm)	4
VC Diameter (mm)	25
SPL (dB@1W/1m)	82.6
RMS Power Handling (w)	30
Usable Frequency Range (Hz)	60 - 10,000

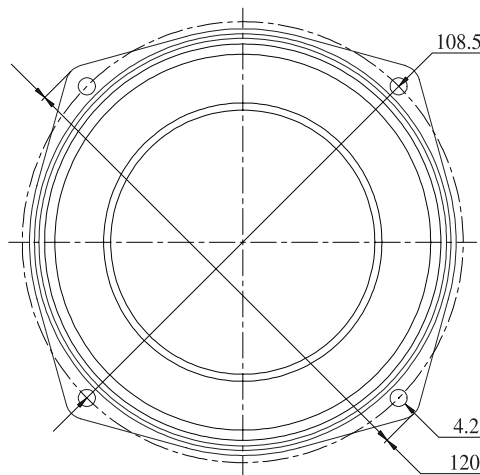
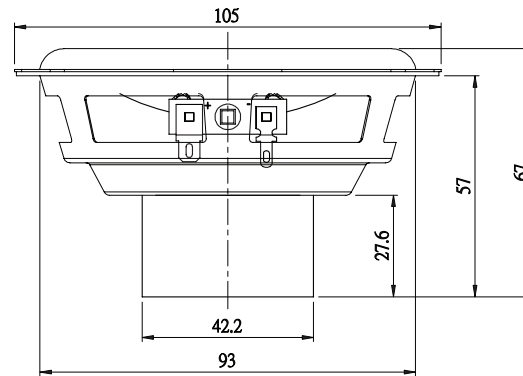

Note: All dimensions in mm.

Frequency Response

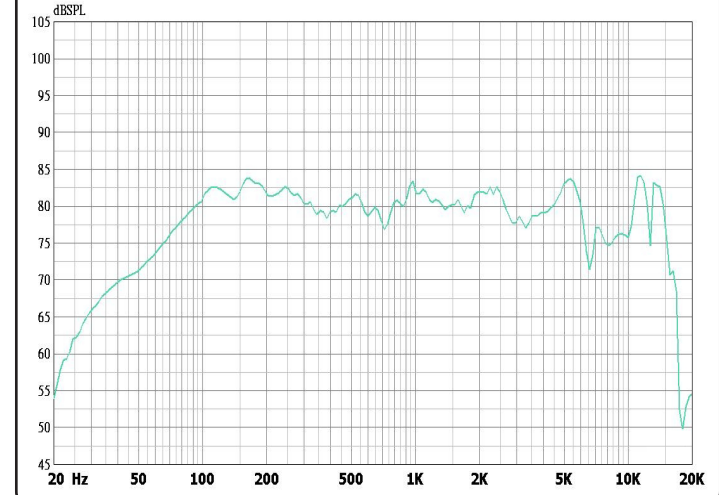

Impedance/Phase

